

WORX

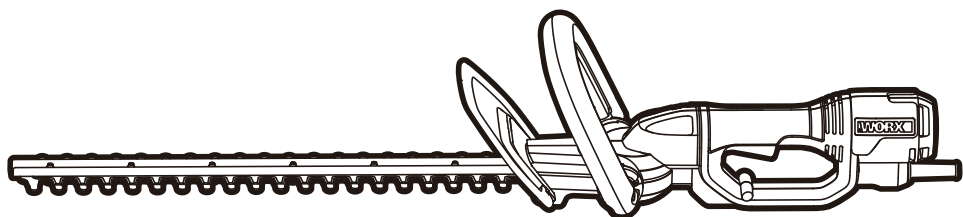

SAFETY AND OPERATING MANUAL

Hedge Trimmer

WG212E

GENERAL POWER TOOL SAFETY WARNINGS



WARNING: Read all safety warnings and all instructions. Failure to follow the warnings and instructions may result in electric shock, fire and/or serious injury.

Save all warnings and instructions for future reference.

The term "power tool" in the warnings refers to your mains-operated (corded) power tool or battery-operated (cordless) power tool.

1) WORK AREA SAFETY

- a) Keep work area clean and well lit.**
Cluttered or dark areas invite accidents.
- b) Do not operate power tools in explosive atmospheres, such as in the presence of flammable liquids, gases or dust.** Power tools create sparks which may ignite the dust or fumes.
- c) Keep children and bystanders away while operating a power tool.**
Distractions can cause you to lose control.

2) ELECTRICAL SAFETY

- a) Power tool plugs must match the outlet. Never modify the plug in any way. Do not use any adapter plugs with earthed (grounded) power tools.**
Unmodified plugs and matching outlets will reduce risk of electric shock.
- b) Avoid body contact with earthed or grounded surfaces, such as pipes, radiators, ranges and refrigerators.**
There is an increased risk of electric shock if your body is earthed or grounded.
- c) Do not expose power tools to rain or wet conditions.** Water entering a power tool will increase the risk of electric shock.
- d) Do not abuse the cord. Never use the cord for carrying, pulling or unplugging the power tool.** Keep cord away from heat, oil, sharp edges or moving parts. Damaged or entangled cords increase the risk of electric shock.
- e) When operating a power tool outdoors, use an extension cord suitable for outdoor use.** Use of a cord

suitable for outdoor use reduces the risk of electric shock.

- f) If operating a power tool in a damp location is unavoidable, use a residual current device (RCD) protected supply.** Use of an RCD reduces the risk of electric shock.

3) PERSONAL SAFETY

- a) Stay alert, watch what you are doing and use common sense when operating a power tool. Do not use a power tool while you are tired or under the influence of drugs, alcohol or medication.** A moment of inattention while operating power tools may result in serious personal injury.
- b) Use personal protective equipment. Always wear eye protection.** Protective equipment such as dust mask, non-skid safety shoes, hard hat, or hearing protection used for appropriate conditions will reduce personal injuries.
- c) Prevent unintentional starting. Ensure the switch is in the off-position before connecting to power source and/or battery pack, picking up or carrying the tool.** Carrying power tools with your finger on the switch or energising power tools that have the switch on invites accidents.
- d) Remove any adjusting key or wrench before turning the power tool on.** A wrench or a key left attached to a rotating part of the power tool may result in personal injury.
- e) Do not overreach. Keep proper footing and balance at all times.** This enables better control of the power tool in unexpected situations.
- f) Dress properly. Do not wear loose clothing or jewellery. Keep your hair, clothing and gloves away from moving parts.** Loose clothes, jewellery or long hair can be caught in moving parts.
- g) If devices are provided for the connection of dust extraction and collection facilities, ensure these are connected and properly used.** Use of these devices can reduce dust-related hazards.

4) POWER TOOL USE AND CARE

- a) **Do not force the power tool. Use the correct power tool for your application.** The correct power tool will do the job better and safer at the rate for which it was designed.
- b) **Do not use the power tool if the switch does not turn it on and off.** Any power tool that cannot be controlled with the switch is dangerous and must be repaired.
- c) **Disconnect the plug from the power source and/or the battery pack from the power tool before making any adjustments, changing accessories, or storing power tools.** Such preventive safety measures reduce the risk of starting the power tool accidentally.
- d) **Store idle power tools out of the reach of children and do not allow persons unfamiliar with the power tool or these instructions to operate the power tool.** Power tools are dangerous in the hands of untrained users.
- e) **Maintain power tools. Check for misalignment or binding of moving parts, breakage of parts and any other condition that may affect the power tool's operation.** If damaged, have the power tool repaired before use. Many accidents are caused by poorly maintained power tools.
- f) **Keep cutting tools sharp and clean.** Properly maintained cutting tools with sharp cutting edges are less likely to bind and are easier to control.
- g) **Use the power tool, accessories and tool bits etc. in accordance with these instructions, taking into account the working conditions and the work to be performed.** Use of the power tool for operations different from those intended could result in a hazardous situation.

5) SERVICE

- a) **Have your power tool serviced by a qualified repair person using only identical replacement parts.** This will ensure that the safety of the power tool is maintained.

ADDITIONAL SAFETY POINTS FOR YOUR HEDGE TRIMMER

1. **Keep all parts of the body away from the cutter blade. Do not remove cut material or hold material to be cut when blades are moving. Make sure the switch is off when clearing jammed material.** A moment of inattention while operating the hedge trimmer may result in serious personal injury.
2. **Carry the hedge trimmer by the handle with the cutter blade stopped. When transporting or storing the hedge trimmer always fit the cutting device cover.** Proper handling of the hedge trimmer will reduce possible personal injury from the cutter blades.
3. **Hold the power tool by insulated gripping surfaces only, because the cutter blade may contact hidden wiring or its own cord.** Cutter blades contacting a "live" wire may make exposed metal parts of the power tool "live" and could give the operator an electric shock.
4. **Keep cable away from cutting area.** During operation the cable may be hidden in shrubs and can be accidentally cut by the blade.
5. **Check the hedge for foreign objects, e.g. wire fences**
6. **Hold the hedge trimmer properly, e.g. with both hands if two handles are provided**

SYMBOLS



To reduce the risk of injury, user must read instruction manual



Wear ear protection



Wear eye protection



Wear dust mask



Do not expose to moisture



Remove plug from the mains immediately if the cable is damaged or cut

4



Double insulation



Keep hands away



RCM marking

N5112

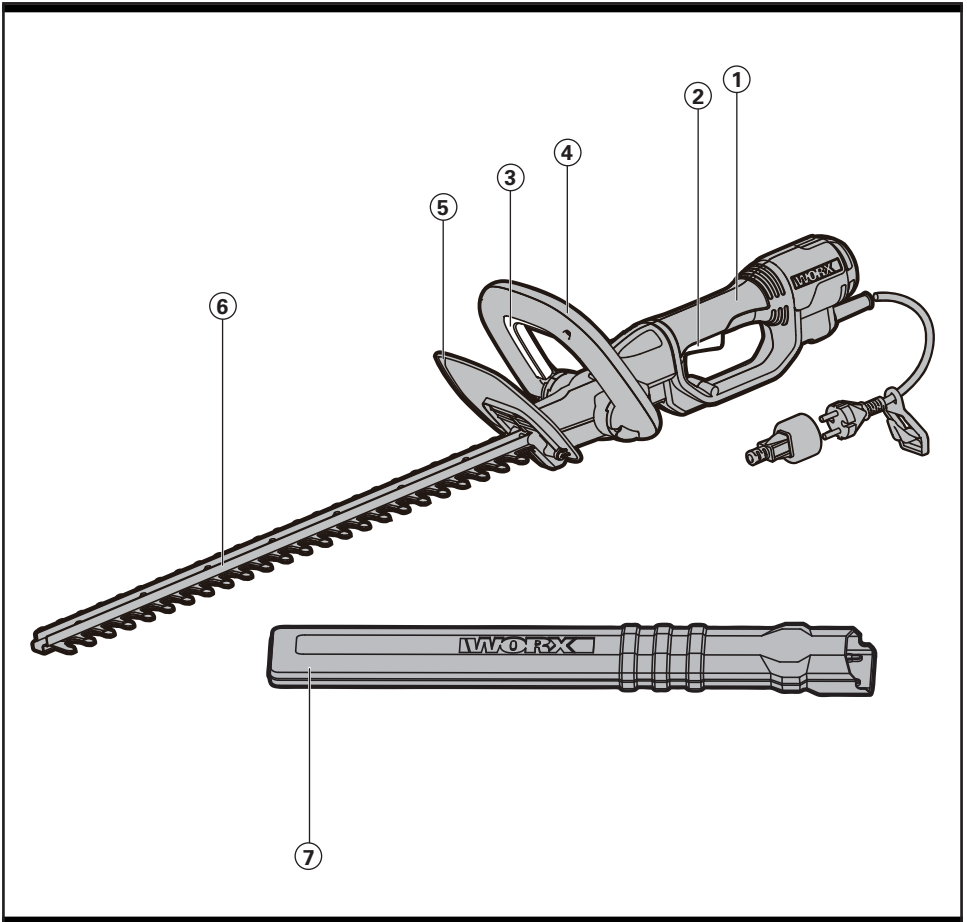

1. REAR HANDLE

2. REAR SWITCH LEVER

3. FRONT SWITCH LEVER

4. FRONT HANDLE

5. SAFETY GUARD

6. BLADE

7. BLADE SHEATH*

* Not all the accessories illustrated or described are included in standard delivery.

TECHNICAL DATA

Rated voltage	230-240V ~ 50Hz
Rated power	500W
Rated no load speed	2600/min
Blade length	51cm
Cutting diameter	17mm
Machine weight	2.4kg
Protection class	□ / II

ACCESSORIES

Safety guard	1
Blade sheath	1

We recommend that you purchase your accessories from the same store that sold you the tool. Use good quality accessories marked with a well-known brand name. Choose the type according to the work you intend to undertake. Refer to the accessory packaging for further details. Store personnel can assist you and offer advice.

OPERATING INSTRUCTIONS

WARNING! Do not use the product without attaching the guard and front handle.

INTENDED USE

This machine is intended to be used domestically for cutting and trimming hedges and bushes.

1. ASSEMBLY OF THE GUARD (See Fig. A)

Insert the Safety Guard (5) into the slot as illustrated in Fig A;

Use two screws to fix the guard securely; making sure it is securely attached.

2. FRONT HANDLE ASSEMBLY

The Front Handle (4) must be assembled before use:

- 1) Attach the Front Handle to the housing. Push the small button (a) inside first. Make sure the protruding marks on the Front Handle fit perfectly into the matching indentation on the housing. (See Fig. B & C)
- 2) Insert and tighten the 4 screws.
- 3) Check whether handle is firmly secured, if not retighten the screws.

Make sure the handle is securely attached in place.

3. MAINS SUPPLY CABLE STRAIN RELIEF (See Fig .D)

An extension cord retainer is supplied to reduce strain on the power cord. To use this feature, form a loop at the end of the extension cable and bring this through the opening at the bottom of the Extension Cord Retainer, then wrap the end of the loop around the hook and pull to tighten.

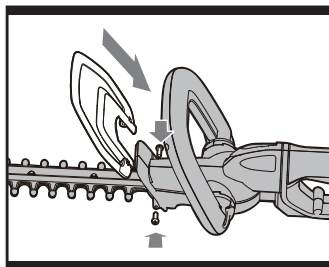

A

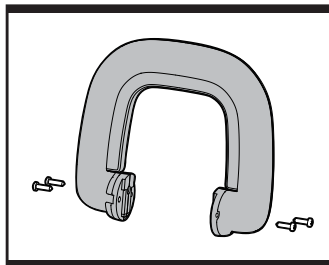

B

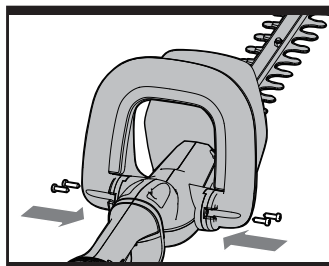

C

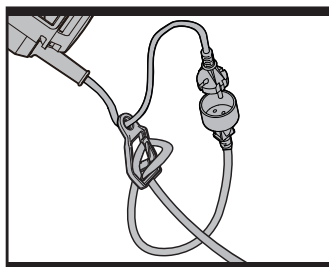

D

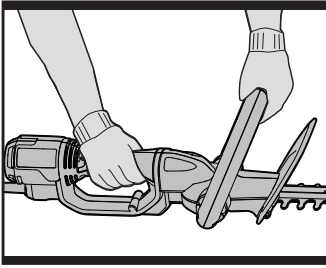

E

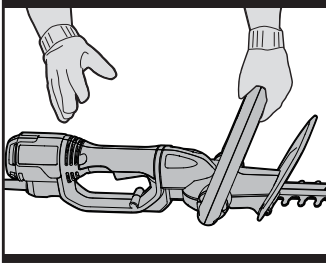

F

8

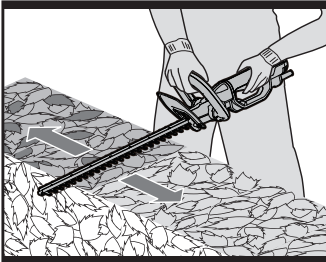

G

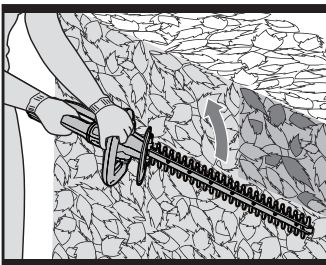

H

4. STARTING AND STOPPING (See fig E, F) BEFORE STARTING YOUR HEDGE TRIMMER

Remove Blade Sheath (7).

TO START YOUR HEDGE TRIMMER

There are two switch levers fitted in your Hedge trimmer (2&3).

Both switch levers need to be depressed for the product to **START**. Depress and hold the Front Switch Lever (3) and depress the Rear Switch Lever (2). (See Fig. E)

TO STOP YOUR HEDGE TRIMMER

Move Hedge trimmer away from cutting area before stopping.

To **STOP**, release one of the switch levers. (See Fig. F)



WARNING: If any parts are missing, damaged or broken, do not operate your Hedge trimmer until all damaged parts have been replaced or repaired.

Failure to do so could result in serious personal injury. **DO NOT USE WITHOUT HANDLE AND GUARD**

5. HOW TO USE YOUR HEDGE TRIMMER

Inspect the area to be cut before each use, remove objects which can be thrown or become entangled in the cutting blades.

Always hold the Hedge trimmer with both hands and with the blade away from you before turning it on.

Always keep the power cord behind the Hedge trimmer when in use. Do not place it over the hedge that you are trimming where it may be cut by the blade.

When trimming new growth, use a wide sweeping action so that the stems are fed directly into the blade. Allow the cutting blades to reach full speed before entering the material to be cut.

Always work going away from people and solid objects such as walls, large stones, trees, vehicles etc.

If the blade stalls, immediately stop the Hedge trimmer. Disconnect the Hedge trimmer from the mains and clear the jammed debris from the cutting blades.

Wear gloves when trimming thorny or prickly growth. Move the Hedge trimmer to feed the branches directly into the blade cutting edges.

Do not try to cut stems that are too large to feed into the cutting blade.

TOP CUTTING (See G)

Use a wide sweeping motion. A slight downward tilt of the cutting blades in the direction of motion gives the best cutting results.

SIDE CUTTING (See H)

When trimming the sides of the hedge, begin at the bottom and cut upwards, tapering the hedge inward

at the top. This shape will expose more of the hedge, resulting in a more uniform growth.

WARNING: Check extension cords before each use. If damaged replace immediately. Never use your tool with a damaged cord since touching the damaged area could cause electrical shock resulting in serious injury.

If the supply cord is damaged, it should be replaced by a local approved Service Centre.

Take care not to expose this tool to rain.

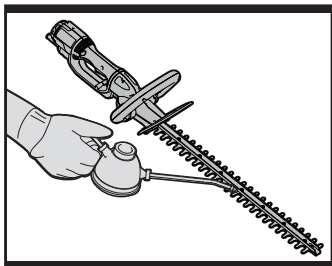

MAINTENANCE

CLEANING

Disconnect from mains electrics supply. Using a soft brush-remove debris from all air intakes and cutting blade.

If the supply cord is damaged, it must be replaced by the manufacturer, its service agent or similarly qualified persons in order to avoid a hazard.

Wipe over surface of your Hedge trimmer with a dry cloth.

WARNING! Never use water for cleaning your Hedge trimmer. Do not clean with chemicals, including petrol, or solvents as this can damage your hedge trimmer.

LUBRICATING THE CUTTING BLADE

For easier operation and longer life, lubricate the cutting blades before and after each use. Before lubricating, make sure your Hedge trimmer is disconnected from the mains electricity supply. Apply the oil so that it runs between the two blades. (See Fig. I)

Your trimmer should be stopped, disconnected and oiled occasionally during use.

AT THE END OF THE CUTTING SEASON

Clean your Hedge trimmer thoroughly.

Check that all nuts and bolts are secure.

Visually inspect the Hedge trimmer for any worn or damaged parts.

TO STORE YOUR HEDGE TRIMMER

Store the hedge trimmer in a secure, dry place out of the reach of children. Do not place other objects on top of the machine.

WORX
it's your nature

Copyright © 2013, Positec. All Rights Reserved.
2GHT13EPK11001A0